



# 中山市川狼五金制品厂

ZHONG SHAN CHUAN LANG LIGHTING CO., LTD

型号: 碟狼507-100W-T90

碟狼507-200W-T90

碟狼507-300W-T90

碟狼507-400W-T90

碟狼507-500W-T90

碟狼507-600W-T90

外观图



碟狼507-100W-T90

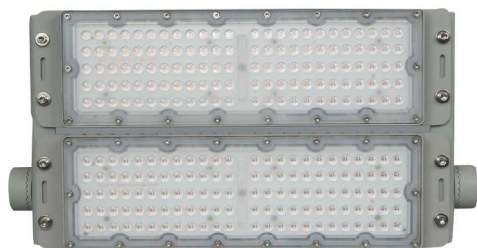

碟狼507-200W-T90



碟狼507-300W-T90



碟狼507-400W-T90



# 外观图



碟狼507-500W-T90



碟狼507-600W-T90



# 线条图

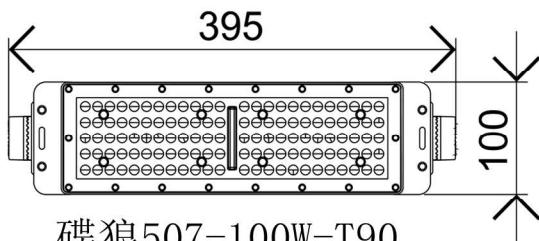
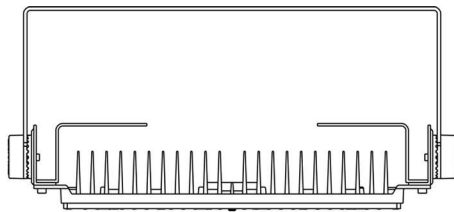

碟狼507-100W-T90

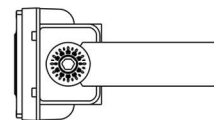
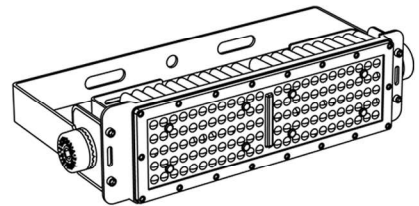

线条图

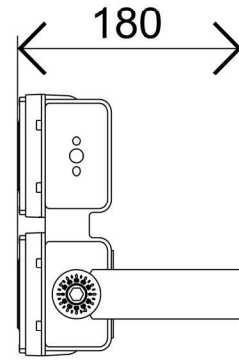
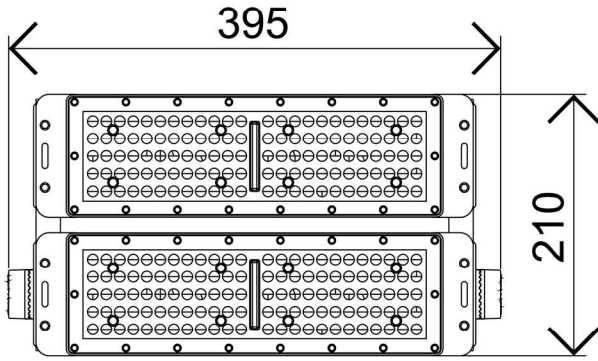
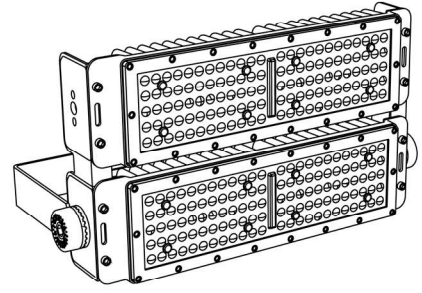
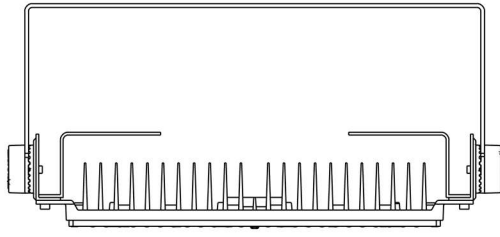

碟狼507-200W-T90

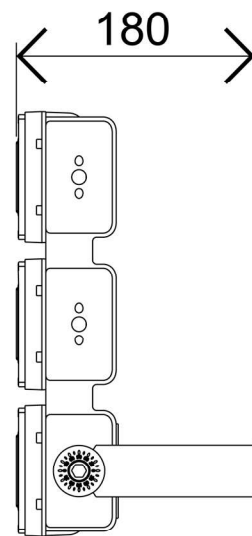
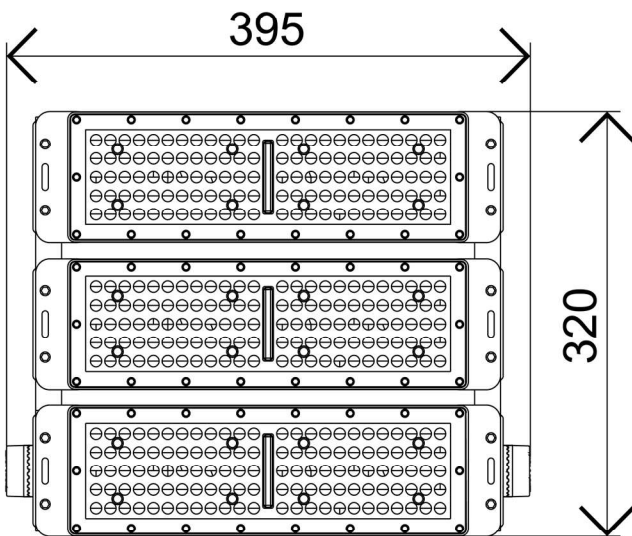
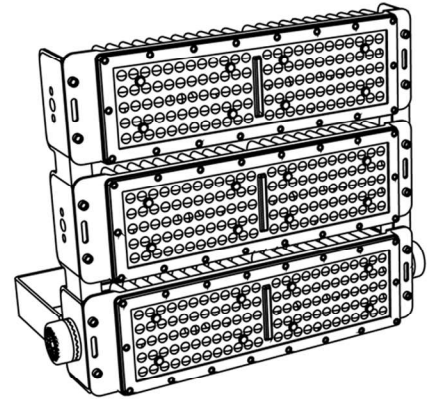
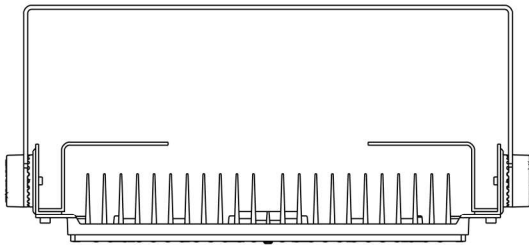

碟狼507-300W-T90

线条图

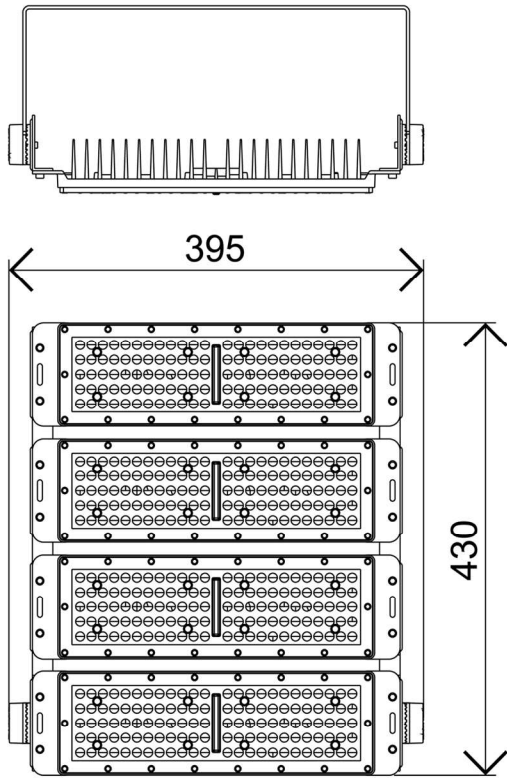

碟狼507-400W-T90

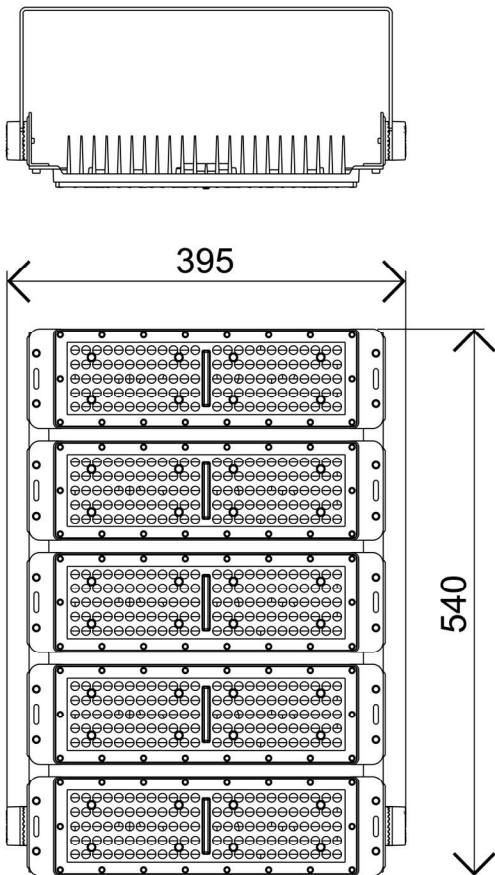

碟狼507-500W-T90

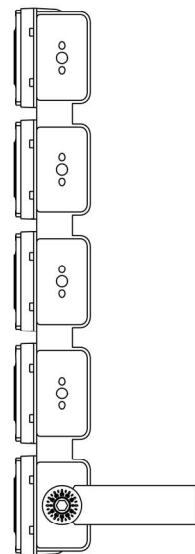
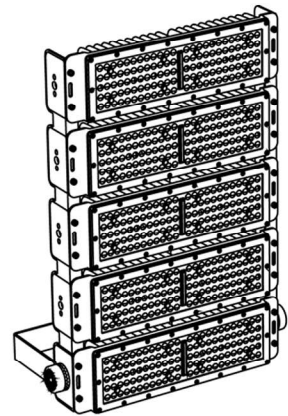
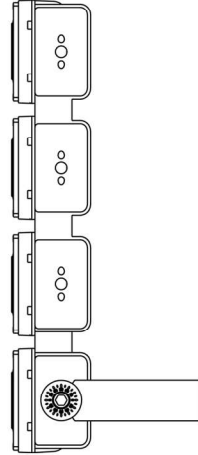
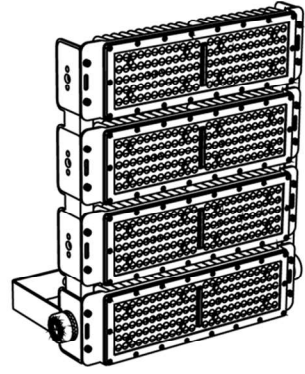

线条图

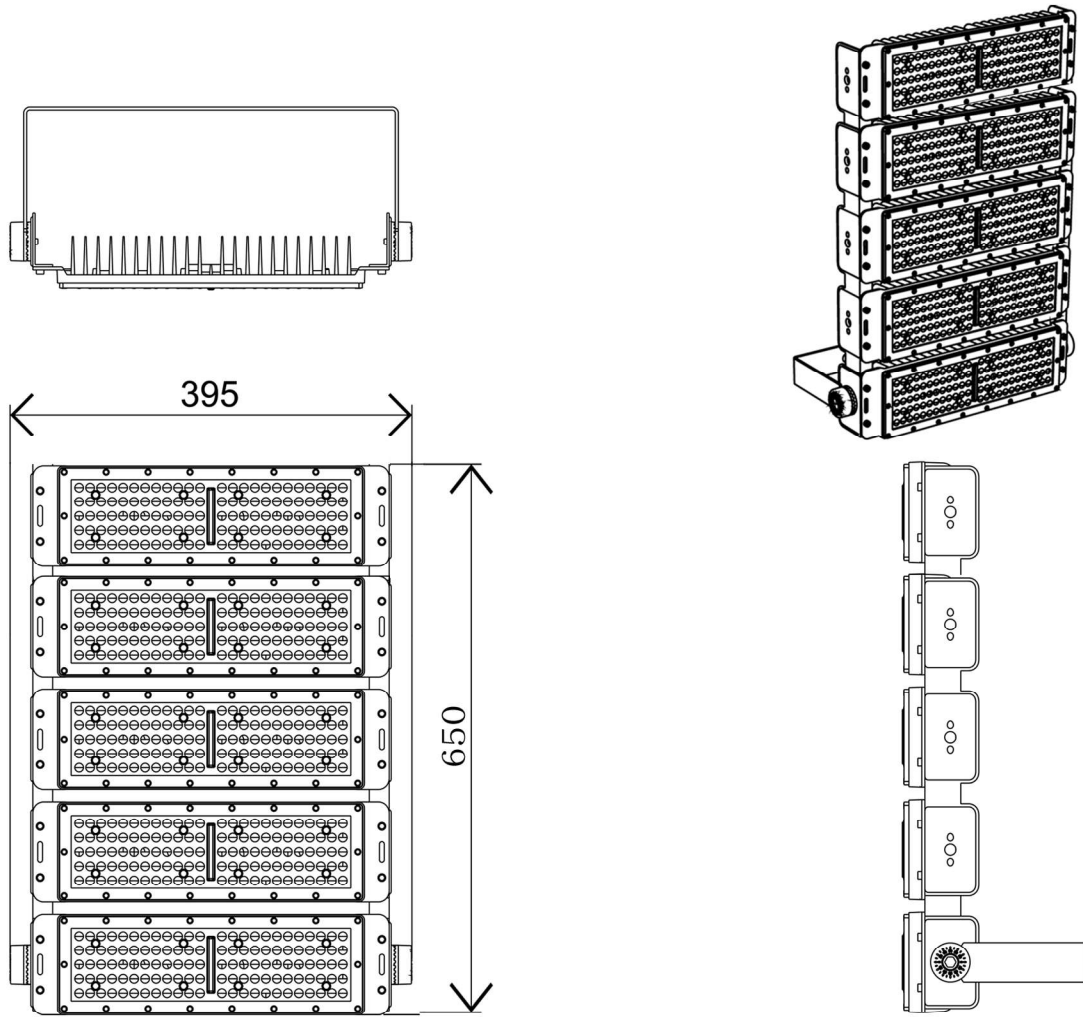

碟狼507-600W-T90

铝基板-透镜

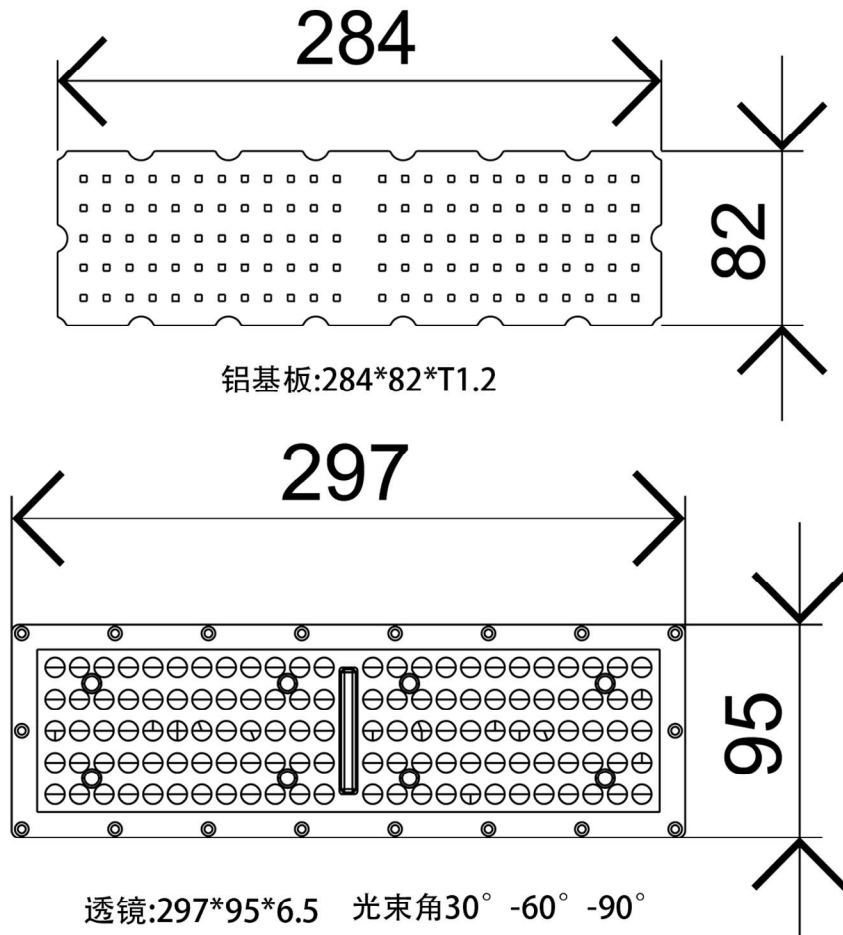

铝基板:284\*82\*T1.2

透镜:297\*95\*6.5 光束角30° -60° -90°

灯体尺寸孔位

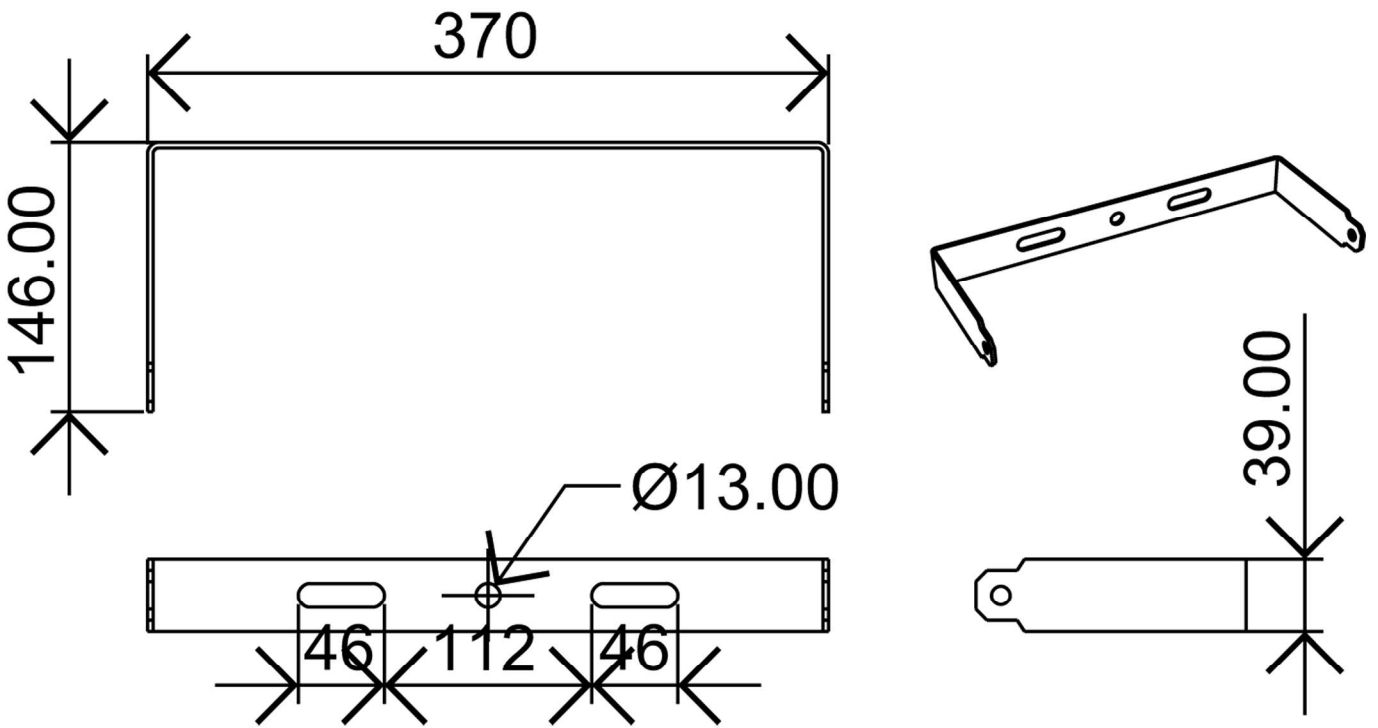
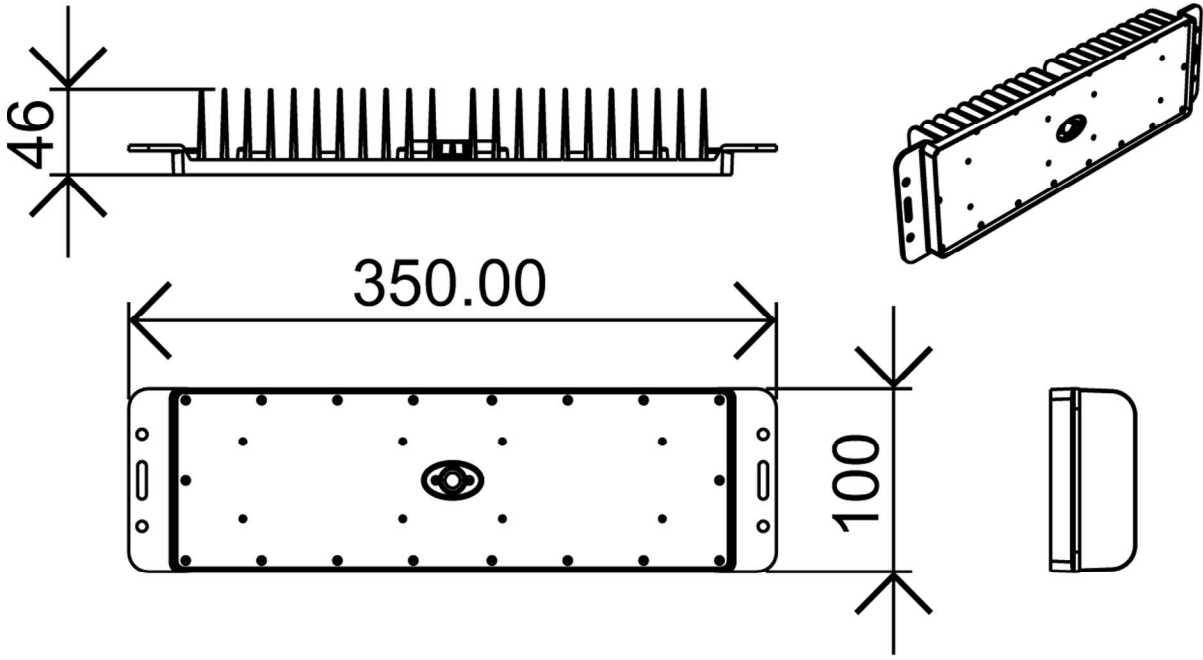

## 包装尺寸

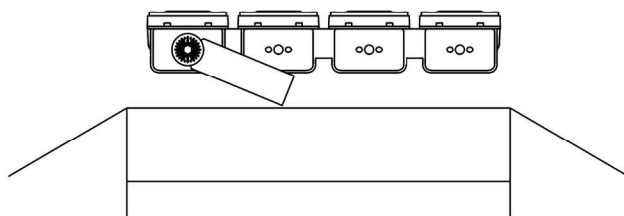
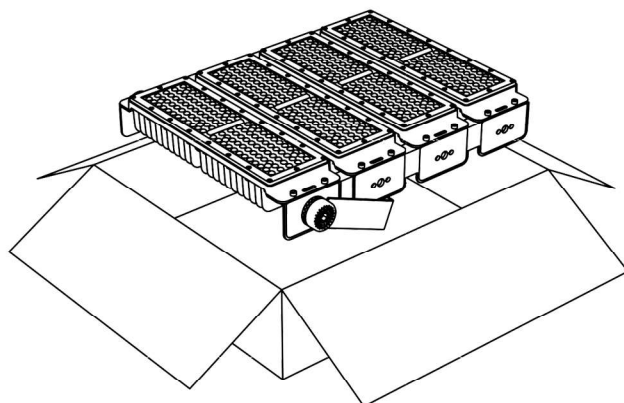
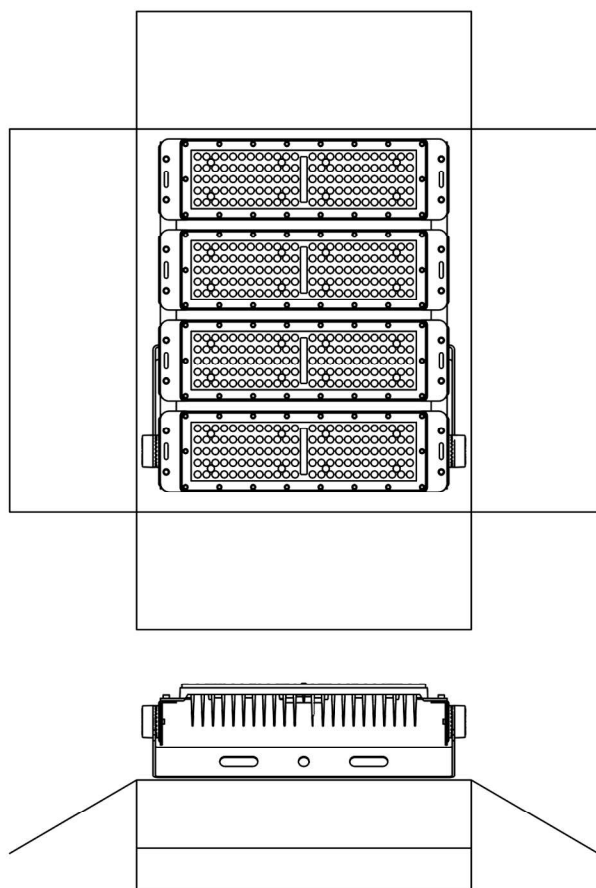

型号: 碟狼507-100W-T90

外箱尺寸: 190mm\*400mm\*H120mm

包装总重量: 2.27KG

碟狼507-200W-T90

外箱尺寸: 230mm\*400mm\*H120mm

包装总重量: 3.447KG

碟狼507-300W-T90

外箱尺寸: 350mm\*400mm\*H120mm

包装总重量: 5.07KG

碟狼507-400W-T90

外箱尺寸: 470mm\*400mm\*H120mm

包装总重量: 6.2KG

碟狼507-500W-T90

外箱尺寸: 590mm\*400mm\*H120mm

包装总重量: 7.7KG

碟狼507-600W-T90

外箱尺寸: 710mm\*400mm\*H120mm

包装总重量: 9.2KG